

Leone offers a wide selection of pliers and orthodontic instruments, some of which are marked with the red symbol *** to underline their quality.

These instruments are made of stainless steel of a superior strength and guaranteed against any kind of sterilization processes. Hard metal cutting inserts and tips are gold brazed to the pliers body to afford longer instrument life.

Shape and screw joints are ergonomically designed to meet any orthodontic requirement.

cutting inserts and tips ***

made of hard metal

*** stainless steel

high resistance

shape and screw joint ***

ergonomically designed to meet any orthodontic requirement

*** gold-based brazing

for longer instrument life



P1900-00 * * *
BIRD BEAK PLIERS
ANGLE STYLE

Necessary for working round wires up to .032" (0,80 mm) in diameter. The beaks are .040" at the tip. A 9° angle is ground on the sides of pyramid beak to allow for wire springback. Beaks are parallel at .020" (0,51 mm) pliers opening.



P1901-00 * * *
LOOP FORMING PLIERS
TWEED STYLE

A pliers designed to make loops in round or rectangular wires up to .022"x.028" (0,56x0,71 mm). The cylindrical beaks has two sections: .043" (1,09 mm) and .063" (1,60 mm).

P1450-00
REPLACEMENT TIPS FOR P1901-00



P1902-00 * * *
LOOP FORMING PLIERS
TWEED STYLE

A pliers designed to make in wires up to .022" (0,56 mm).



P1352-00
FLAT-TAPERED PLIERS
TWEED STYLE

With tapered beaks to form small sized loops and springs.



P1903-00
YOUNG STYLE PLIERS

For wires up to .040" (1,02 mm).



P1156-00 * * *
OPTICAL PLIERS MERRIFIELD STYLE

Cone and concave beak pliers in stainless steel with tungsten carbide inserts designed to make loops, omega-loops and distal stops in round and rectangular wires. Approved by the C.H. Tweed International Foundation.



P1904-00
LIGHT WIRE PLIERS

* * *

Longer and more tapered beaks than Angle pliers. Excellent for bending small diameter loops. For wires up to .018" (0,46 mm).



P1130-00
HOLLOW-CHOP PLIERS



For contouring archwires and forming cuspid offsets.

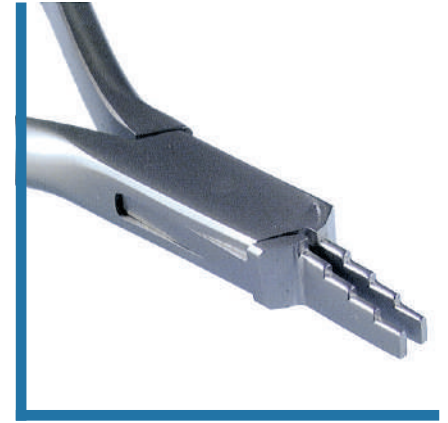

P1073-00
LOOP CLOSING PLIERS
NANCE STYLE

With 4 sectioned tip for forming various size loops in rectangular and round wires.
For wires up to .028" (0,71 mm).



P1154-00
MEDIUM WIRE PLIERS
OPTICAL STYLE



For wires up to .028" (0,71 mm).



P1155-00
MEDIUM WIRE PLIERS
OPTICAL STYLE



For wires up to .028" (0,71 mm).



P1905-00 * * *
**RECTANGULAR ARCH PLIERS
TWEED STYLE SHORT JAW**

For use with square or rectangular wires. The blades are designed to be parallel at .020" (0,51 mm) pliers opening. Working edges are carefully bevelled with a diamond hone to prevent wire scoring.



P1906-00 * * *
**THREE JAW PLIERS
ADERER STYLE
MEDIUM**

For wires up to .036" (0,91 mm).



P1075-01 * * *
**THREE JAW PLIERS
ADERER STYLE
THIN**

For round wires up to .020" (0,51 mm) and rectangular up to .021"x.025" (0,53x0,64 mm).

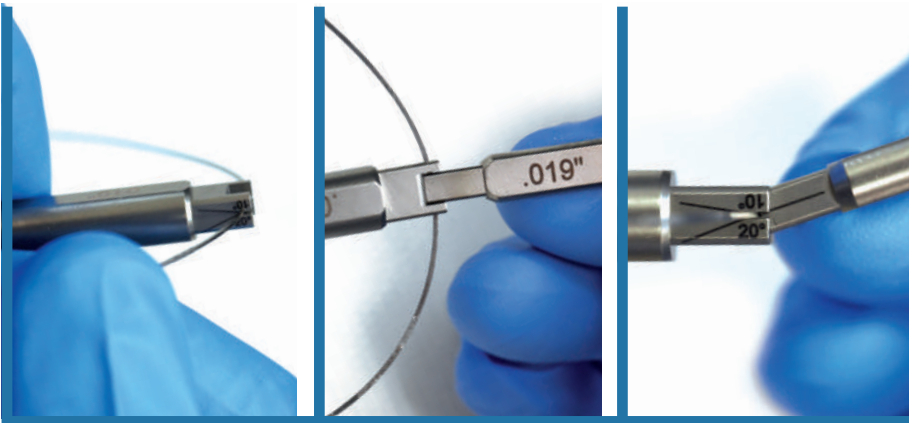

P1635-00
TORQUING INSTRUMENT FOR WIRE .019"X.025" AND .021"X.025"/.027"

A device consisting of two components to easily apply torque to a portion of arch wire in proximity of a specific bracket. The instrument with the U end is used to mark out and maintain the selected portion of the arch wire. The additional instrument is used to firmly keep the rectangular wire and to apply the desired torque degrees. Thanks to the presence of a laser marked protractor, it is possible to check the degrees of torque given. One instrument end is for arch wires .019"x.025", the other for .021"x.025"/.027"



P1621-00
**INSTRUMENT
FOR ENDORAL ACTIVATION**

Indicated for multifunctional orthodontic screws.



P1907-00 * * *
HOW STYLE PLIERS STRAIGHT

The 3/32" (2,4 mm) gripping pads are serrated and shaped so that their centre line coincides with the axis of rotation of the pliers. Beaks are rounded to be completely lip safe.



P1908-00 * * *
HOW STYLE PLIERS STRAIGHT

Exactly the same as P1097-00. With 1/8" (3,2 mm) gripping pads.



P1909-00 * * *
HOW STYLE PLIERS OFFSET

Exactly the same as P1908-00 with tips incorporating a 45° offset angle.



P1910-00 * * *
WEINGART STYLE PLIERS

Classical design, the tips are carefully rounded to make this pliers completely mouth safe. Useful for removal of ceramics.



P1912-00 * * *
ARCH FORMING AND CONTOURING PLIERS

With three grooves, for wires .016", .018" and .022".

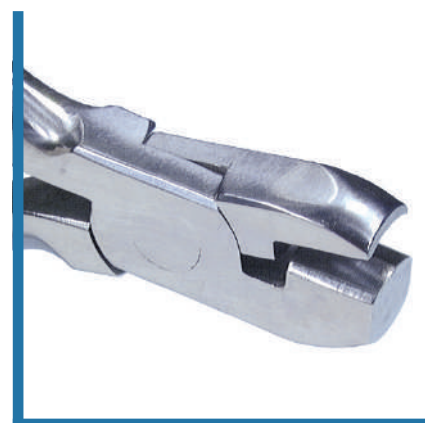

P1913-00 * * *
ARCH FORMING PLIERS

Without grooves.



P1916-00
DISTAL END CUTTER WITH SAFETY HOLD

* * *

The particular design of this cutter allows distal end archwires be cut in the patient mouth safely. It cuts the wire and then safely holds the loose distal end.

- Caution:** maximum cutting capacity:
- rectangular wire up to .022"x.028" (0,56x0,71 mm);
 - round wire up to .020" (0,51 mm);
 - twist wire up to .016" (0,41 mm).



P1915-00
DISTAL END CUTTER WITH SAFETY HOLD

* * *

The small dimensions do not interfere with quality. It cuts archwires and safely holds the loose distal end.

- Caution:** maximum cutting capacity:
- rectangular wire up to .022"x.028" (0,56x0,71 mm);
 - round wire up to .020" (0,51 mm);
 - twist wire up to .016" (0,41 mm).



P1914-00
MICRO DISTAL END CUTTER WITH SAFETY HOLD
LONG HANDLES

* * *

The retracted position of 10° angled hand grip affords a wider view in the oral cavity.

- Caution:** maximum cutting capacity:
- rectangular wire up to .022"x.028" (0,56x0,71 mm);
 - round wire up to .020" (0,51 mm);
 - twist wire up to .016" (0,41 mm).

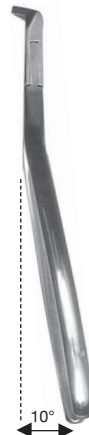

P1911-00
STOP AND SURGICAL HOOK
CRIMPING PLIERS

* * *

A pliers designed to crimp surgical hooks in the archwire. It can also be used to fix round or rectangular stops.



P1917-00
HARD WIRE CUTTER

* * *

For cutting orthodontic wires for fixed technique any size.

Caution: maximum cutting capacity:

- rectangular wire up to .022"x.028" (0,56x0,71 mm);
- round wire up to .020" (0,51 mm).



P1918-00
45° OFFSET LIGATURE CUTTER

* * *

45° offset for easy access to posterior areas thus eliminating any cheek impingement.

Caution: maximum cutting capacity:

- ligature wire up to .014" (0,36 mm).



P1919-00
MINIATURE LIGATURE CUTTER

* * *

For soft wires.

Caution: maximum cutting capacity:

- ligature wire up to .014" (0,36 mm).



P1099-00
HEAVY DUTY CUTTER

For hard wires up to 1,5 mm.



P1920-00 * * *
D.B. BRACKET REMOVING PLIERS

It guarantees comfort of the patient. The sharp beaks fit under bracket flange and remove it with ease.



P1921-00 * * *
D.B. BRACKET REMOVING PLIERS

Designed to remove bonded brackets easily. The sharp beak fits under bracket flange and removes it with ease. It will also remove adhesive from the tooth.

P1451-00
METAL TIP FOR P1921-00

P1452-00
VINYL TUBE - 15 CM FOR P1921-00



P1922-00 * * *
POSTERIOR BAND REMOVING PLIERS LONG

Necessary for removal of posterior bands. A plastic padded tip and a sharp removing beak allow, with a slight pressure, high precision band removal.

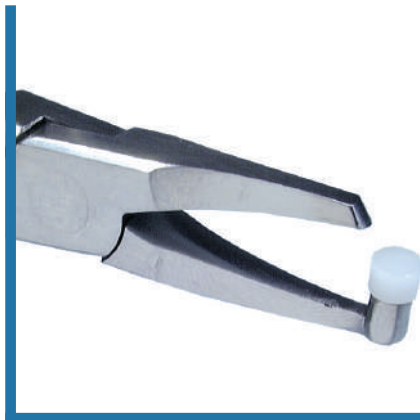

P1923-00 * * *
POSTERIOR BAND REMOVING PLIERS SHORT

Same design and function as P1922-00 but with a short beak for a better occlusal support.

P1453-00
REPLACEMENT PAD 3/16" (4,8 mm) FOR P1922-00 - P1923-00



P1403-00
WRENCH FOR CLASSIX PLIERS

For pliers joint.



P1530-00 * * *
LABORATORY PLIERS ADAMS STYLE

Large tips with tungsten carbide inserts. Necessary for bending wires in the laboratory. A round cone tip of 1,3 mm and a pyramid beak of 1,4 mm. For wires up to 1,5 mm. Excellent for Crozat technique.



P1034-00 * * *
THREE JAW PLIERS ROUND

Very sturdy, does not score wires. Suitable for bending the arms of expanders. For wires up to 1,5 mm.

P1034-93 * * *
THREE JAW PLIERS ROUND WITH P1620-02



P1099-00
HEAVY DUTY CUTTER

For hard wires up to 1,5 mm



P1162-00
UNIVERSAL PLIERS

Extremely tapered design. For wires up to 0,9 mm.



P1163-00
UNIVERSAL PLIERS

Classic design. For wires up to 0,9 mm.



P1097-00
ADAMS CLASP FORMING PLIERS NANCE STYLE

For forming Adams clasps and small stops in the archwires. For wires up to 0,7 mm.



excellent
value
for money

**balanced
articulated joint**

smooth and precise movement

special steel

superior hardness perfect wire hold
resistance to corrosion

ergonomic handles

smooth edges for easy guidance

**tungsten carbide
cutting inserts**

diamond honed for precise wire cutting
and long-lasting results

hard chrome finish

for high resistance during sterilization

Classix pliers and cutters are manufactured with the most advanced manufacturing technology available and superior quality material. They are coming from the need to offer instruments featured by a good value for money.

A range of 10 instruments has been selected to meet any orthodontic basic requirement.

Classix pliers and cutters are manufactured with a special and superior hard steel to afford an optimal wire hold and resistance to corrosion of tips.

All **Classix** instruments feature a special inner balanced joint allowing a smooth and precise, long lasting movement.

Classix cutters' cutting edges have tungsten carbide inserts, diamond honed for precise cutting of wires and pliers' long lifetime. All cutters are entirely hard chrome finished for high resistance during sterilization.

Classix instruments feature ergonomic handles and smooth rounded surfaces to allow the orthodontist for easy handling and best operational precision.



P2101-00 **BIRD BEAK PLIERS ANGLE STYLE**

Necessary for working round wires up to .045" (1,14 mm). Beaks are only .025" (0,64 mm) at the tip to bend loops and omega loops, even small ones. A 10° angle is ground on the sides of the rectangular beak to compensate for wire spring-back in the modelling stage. Beaks are parallel at .020" (0,51 mm) pliers opening and diamond honed to prevent wire scoring.



P2102-00 **OMEGA LOOP FORMING PLIERS TWEED STYLE**

Concave beak is contoured for making more uniform omega loops with ease. The round beak has three sections: .045" (1,14 mm), .060" (1,52 mm), .075" (1,90 mm) and made of a hard electro etched alloy to prevent wire slippage. Tip can be easily replaced with the use of the allen wrench.

P2000-01 REPLACEMENT TIPS FOR P2102-00 Pack: 2 tips and 1 wrench



P2103-00 **THREE-JAW PLIERS**

The central beak is precision aligned and when the pliers is closed, it fits over the level of the two lateral beaks to form bends more acute than 90°. The tips are slightly tapered and diamond honed to prevent wire scoring. For round wires up to .036" (0,9 mm). It allows the activation of quad helix, palatal bars etc. in the oral cavity as well.



P2104-00 **UTILITY PLIERS WEINGART STYLE**

The tips are shaped to firmly hold wires and devices and perfectly angled to enhance the visibility of the operative field. The two beaks are diamond honed to make it lip safe.



P2105-00 **BAND REMOVING PLIERS**

When the pliers is closed, the non-padded remover tip does not get in contact with the aesthetic resin pad: this allows it to make lever on the tube or the accessory, or on the edge of the band facilitating the safe removal from the mouth.

P2000-02 REPLACEMENT PAD 3/16" (4,8 MM) FOR P2105-00



P2106-00
D.B. BRACKET REMOVING PLIERS

The tapered tips wedge between both edges of the base of the bracket and the tooth surface: by slightly lifting off, the bracket is easily removed without any damage to the enamel. Useful also for removal of ceramic brackets.



P2107-00
RECTANGULAR ARCH FORMING PLIERS TWEED STYLE

For handling square or rectangular wires, torqueing and forming precision bends. The beaks are designed to be parallel at .020" (0,51 mm) pliers opening and diamond honed to prevent wire scoring.



P2108-00
DISTAL END CUTTER WITH SAFETY HOLD

Designed for cutting the excess of distal wire and holding the loose archwire safely. The special design and the accurate sharpening of the cutting edges make it to be functional with either thin or coaxial wires.

Caution: maximum cutting capacity: round wires .020" (0,51mm)
rectangular wires .022"x.028" (0,56x0,71 mm).



P2109-00
HARD WIRE CUTTER

The hard construction and the quality of sharpening of the cutting edges allow for use with any section of wire for fixed orthodontics. At maximal closure, the sharpening ends only touch at the tip to ensure precise action with any archwire section.

Caution: maximum cutting capacity: round wires .020" (0,51mm)
rectangular wires .022"x.028" (0,56x0,71 mm).



P2110-00
LIGATURE CUTTER

The tips are 15° angled for better field vision near the bracket's tie wings. The cutting inserts have wide backing ledges to guarantee the maximum anchorage to the body of the instrument.

Caution: maximum cutting capacity: round wires .015" (0,38 mm)

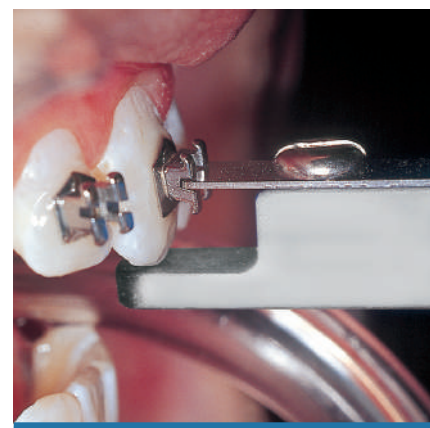

UNIVERSAL BRACKET POSITIONING GAUGES

Made of aluminium and stainless steel. Autoclavable.
Used with either .018" or .022" slot brackets.
Colour coded for immediate identification.

colour		size
green	P1601-00	2 - 2,5 mm
red	P1602-00	3 - 3,5 mm
blue	P1603-00	4 - 4,5 mm
purple	P1604-00	5 - 5,5 mm

P1600-95 Assorted kit of 4



P1509-00 STAINLESS STEEL UNIVERSAL BRACKET ALTIMETER

A small device for measurement of the right height of bracket slots.



P1026-00 D.B. BRACKET TWEEZERS

It holds any type of bracket, from a wide twin to a single one.
Self-locking of the bracket and release by pressure.
Several tweezers can be pre-loaded with brackets to bond them one after the other.



P1098-00
UTILITY INSTRUMENT



P1520-00
SCREWDRIVER

For use with micro spring screws.
Tip of 1,5 mm.



P1630-00
MODELLING SPATULA LE CRON STYLE



P1025-00
DYNAMOMETER

* * *

High precision gauge for measuring tensile and compression forces exerted by springs and elastics for a maximum range of 16 oz (0,4536 Kg). It is calibrated with 1 oz. single line and 4 oz double line increments.

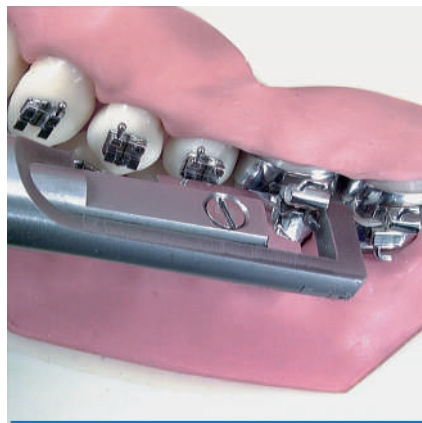

P1090-00
CAP REMOVER
FOR CONVERTIBLE TUBES

* * *

It makes the conversion of rectangular tube easy when banding of the second molar is required. Autoclavable.

P1090-01
REPLACEABLE TIPS P1090-00

Pack of 2



P1001-01 **BAND DRIVER OFFSET TIP**

* * *

Fully made of stainless steel.
For placement and adjustment of bands. Activation is ease in all positions.
Seating pressure range 80 up to 1000 g.

P1000-01 **BAND DRIVER STRAIGHT TIP**

* * *

Exactly the same as P1001-01 but with straight tip.

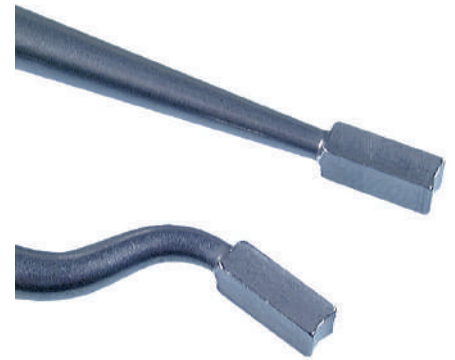

P1002-01 **REPLACEMENT TIP** **FOR P1001-01**

P1003-01 **REPLACEMENT TIP** **FOR P1000-01**



P1077-00 **MERSHON BAND ADAPTER**







P1092-00 **BAND ADAPTER**

The new instrument is simple, user-friendly, practical and economical. It allows the band to be adapted to tooth anatomy, without nicking or damaging it.



**ARM BENDING AND SELF-LOCKING INSTRUMENT^(patented)
FOR EXPANDERS**

Handy instrument to firmly hold the expander; it allows for easy and accurate modeling of the arms along with the special arm bending P1620-02. The instrument ends, with a clutch mechanism, are shaped on the model of expander to avoid damage to the bodies and are kept closed by a cursor clamp device that is turned on and off with a simple thumb action. The edge thickness of the clutching ends is designed to indicate the minimum space between the body of the expander and the palatal vault. By placing the instrument with the screw on the plaster model, the correct inclination and the right height to bend the arms will be clearly visible. It is also useful to test the expander prior to use by opening and closing the expander with the special straight key.

for expanders		
	P0620-00	A0620-08/09/11/13/15 A2620-07/10/12 A2703-06/09 - A2704-06/09 A2705-06/09 - A2706-06/09
	P0630-00	A0630-08/10/12
	P0621-00	A0621-08/11 A1621-08/11/13
	P0625-09	A0625-09 new
	P0625-07	A0625-07 new

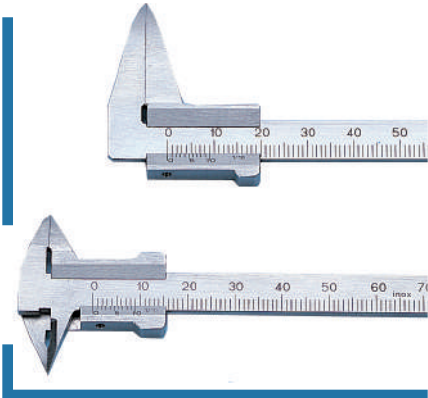
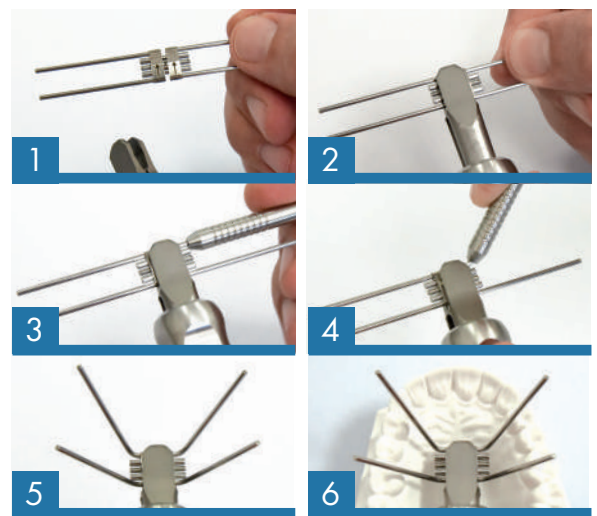

DENTAL VERNIERS

P1078-15 Long tips

P1560-15 Double tips
Specific for inner and outer measurement

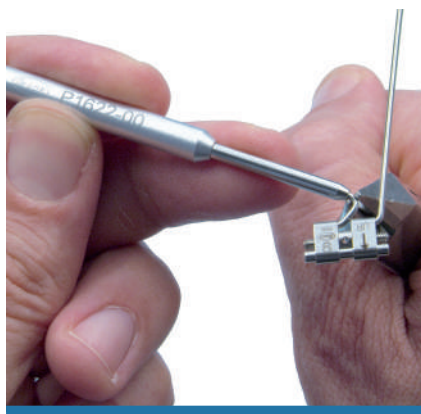

P1622-00
**ARM BENDING INSTRUMENT
FOR FAST BACK**

It facilitates the job of the technician during the construction of the device. It allows to maintain the linearity of the arm which has to slide on the palatal tube. The aluminium handle joined to the tempered steel tube assures a firm grip to get accurate bends.



P1620-02
**ARM BENDING INSTRUMENT
FOR EXPANDERS**

Ideal to bend the expander's arms with ease and precision. Also for expanders with long arms.

TURRET FOR FORMING RECTANGULAR OR ROUND ARCHWIRES

For forming arch wires with or without torque adjustment.
Available in six different versions and colour codes.
The wire slotted body is made of stainless steel.



P1167-00
TURRET
BLUE code

For forming rectangular arch wires
.016" up to .0215".



P1266-00
TURRET
BLACK code

For forming rectangular arch wires with
torque adjustments: 0° - 10° - 16° - 23°.
For use only with wire: .016"x.022".



P1168-00
TURRET
GOLD code

For forming rectangular arch wires with
torque adjustments: 0° - 7° - 10° - 13° - 16°.
For use only with wire: .018".



P1267-00
TURRET
PURPLE code

For forming rectangular arch wires with
torque adjustments: 0° - 10° - 16° - 23°.
For use only with wire: .016"x.016".



P1170-00
TURRET
SILVER code

For forming rectangular arch wires with
torque adjustments: 0° - 7° - 10° - 13° - 16°.
For use only with wire: .022".



P1169-00
TURRET
GREEN code

For forming round arch wires:
.014" - .016" - .018" - .020".

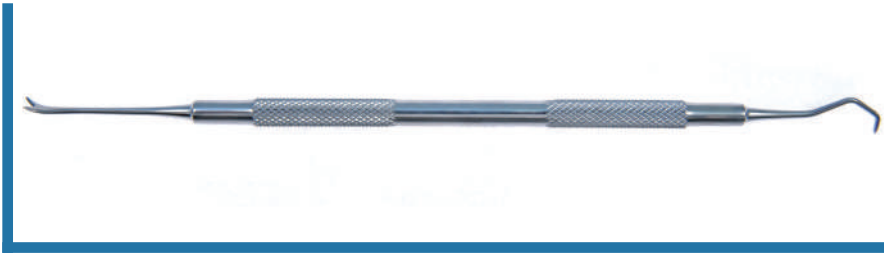

P1139-00
LIGATURE TUCKER

Double ended for placement or removal of elastics. Necessary for tucking metal ligatures.

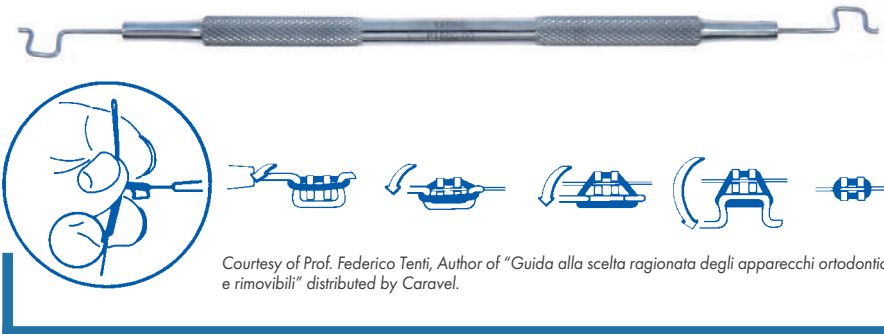

P1500-00
ELASTIC LIGATURE THREADER

It facilitates placement of elastic ligatures under bracket tie wings.

Courtesy of Prof. Federico Tenti, Author of "Guida alla scelta ragionata degli apparecchi ortodontici e rimovibili" distributed by Caravel.



P1576-00
LIGATURE AND ARCHWIRE TUCKER

Useful for insertion of the arch wire into bracket slot. It is also used to tuck metal ligatures and to apply elastic chains.



P1505-01 * * *
TWISTER
FOR PREFORMED LIGATURE TIES
K4430-25 AND K4480-30

Fully made of stainless steel. Push the back button to insert the preformed ligature tie. It makes position and final ligation easy.



P1506-00
INSTRUMENT FOR F1000
SELF-LIGATING BRACKETS

It allows for arch wire engagement by holding the wire into the slot. With a gentle pressure, it also drives the ligation clip of bracket to full closing.



P1515-00
FAN-TYPE HAND WRENCH

Thanks to its design, this screwdriver allows you to easily tighten the fixing screws for support of the Telescopic Advancer device.



LIGATURE TYING PLIER MATHIEU STYLE

P1160-00 Tips di 2,5 mm

P1161-00 Tips di 1,5 mm



P1141-00
SEPARATOR PLACING PLIERS

For use with radio opaque separators K6378-00.

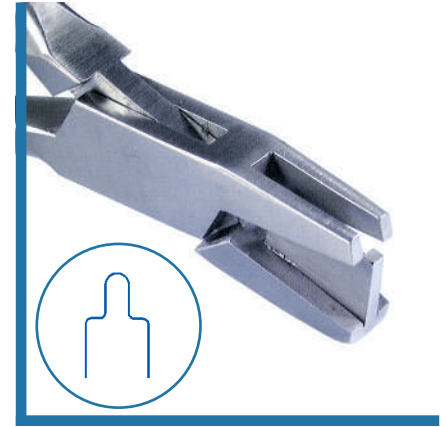

P1142-00
LIGATURE WIRE FORMING PLIERS

For soft wires up to .014" (0,36 mm).



P1089-00
MOSQUITO FORCEPS OFFSET

P1088-00
MOSQUITO FORCEPS STRAIGHT



P3000-01
LIP RETRACTOR

Well tolerated by patient, it allows an excellent visibility and ease of use. The plastic retractors are connected by a sturdy steel bridge which does not interfere with the field of vision.

Necessary with the direct bonding technique and for taking oral photographs. Autoclavable. Transparent.



P3000-91
LIP RETRACTOR KIT

Kit content:

- 5 couples of transparent retractors,
- 2 bridges.